

Panasonic®

Operating Instructions

2.4 GHz Digital Cordless Phone

Model No. **KX-TG2620**

Model No. **KX-TG2621**

2.4 GHz Digital Cordless Phone
with Two Handsets

Model No. **KX-TG2622**

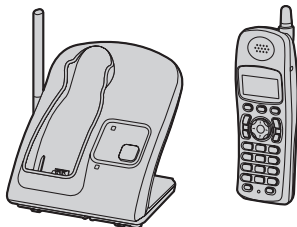

Model shown is KX-TG2620.

This unit is compatible with Caller ID. To use this feature, you must subscribe to the appropriate service offered by your service provider.

Charge the handset battery for 6 hours before initial use.

Please read these Operating Instructions before using the unit and save for future reference.

For assistance, visit our website:

<http://www.panasonic.com/phonehelp> for customers in the U.S.A. or Puerto Rico.

Important safety instructions

When using the product, basic safety precautions should always be followed to reduce the risk of fire, electric shock, or personal injury.

1. Read all instructions carefully.
2. Follow all warnings and instructions marked on the product.
3. Unplug the product from power outlets before cleaning. Do not use liquid or aerosol cleaners. Use a moist cloth for cleaning.
4. Do not use the product near water, for example near a bathtub, wash bowl, kitchen sink, etc.
5. Place the product securely on a stable surface. Serious damage and/or injury may result if the product falls.
6. Do not cover slots and openings on the product. They are provided for ventilation and protection against overheating. Never place the product near radiators, or in a place where proper ventilation is not provided.
7. Use only the power source marked on the product. If you are not sure of the type of power supplied to your home, consult your dealer or local power company.
8. Do not place objects on the power cord. Install the product where no one can step or trip on the cord.
9. Do not overload power outlets and extension cords. This can result in the risk of fire or electric shock.
10. Never push any objects through slots in the product. This may result in the

risk of fire or electric shock. Never spill any liquid on the product.

11. To reduce the risk of electric shock, do not disassemble the product. Take the product to an authorized service center when service is required. Opening or removing covers may expose you to dangerous voltages or other risks. Incorrect reassembly can cause electric shock when the product is subsequently used.
12. Unplug the product from power outlets and take to an authorized service center when the following conditions occur:
 - A. When the power cord is damaged or frayed.
 - B. If liquid has been spilled into the product.
 - C. If the product has been exposed to rain or water.
 - D. If the product does not work normally by following the operating instructions. Adjust only controls covered by the operating instructions. Improper adjustment may require extensive work by an authorized service center.
 - E. If the product has been dropped or physically damaged.
 - F. If the product exhibits a distinct change in performance.
13. During thunderstorms, avoid using telephones except cordless types. There may be a remote risk of an electric shock from lightning.
14. Do not use the product to report a gas leak, when in the vicinity of the leak.

SAVE THESE INSTRUCTIONS

CAUTION:

Installation

- Never install telephone wiring during a lightning storm.
- Never install telephone jacks in wet locations unless the jack is specifically designed for wet locations.
- Never touch uninsulated telephone wires or terminals unless the telephone line has been disconnected at the network interface.
- Use caution when installing or modifying telephone lines.
- Do not touch the plug with wet hands.
- The AC adaptor is used as the main disconnect device. Ensure that the AC outlet is installed near the product and is easily accessible.

Battery

To reduce the risk of fire or injury to persons, read and follow these instructions.

- Use only the battery(ies) specified.
- Do not dispose of the battery(ies) in a fire. They may explode. Check with local waste management codes for special disposal instructions.
- Do not open or mutilate the battery(ies). Released electrolyte is corrosive and may cause burns or injury to the eyes or skin. The electrolyte may be toxic if swallowed.
- Exercise care when handling the battery(ies). Do not allow conductive materials such as rings, bracelets or keys to touch the battery(ies), otherwise a short circuit may cause the battery(ies) and/or the conductive material to overheat and cause burns.

- Charge the battery(ies) provided, or identified for use with the product only, in accordance with the instructions and limitations specified in this manual.

WARNING:

- To prevent the risk of fire or electrical shock, do not expose the product to rain or any type of moisture.
- Unplug the product from power outlets if it emits smoke, an abnormal smell, or makes an unusual noise. These conditions can cause fire or electric shock. Confirm that smoke has stopped emitting and contact the Panasonic Call Center at 1-800-211-PANA (1-800-211-7262).

Medical

- Consult the manufacturer of any personal medical devices, such as pacemakers or hearing aids, to determine if they are adequately shielded from external RF (radio frequency) energy. (The product operates in the frequency range of 2.4 GHz to 2.48 GHz, and the power output is 100 mW (max.)) Do not use the product in health care facilities if any regulations posted in the area instruct you not to do so. Hospitals or health care facilities may be using equipment that could be sensitive to external RF energy.

For best performance

Base unit location/avoiding noise

The base unit and other compatible Panasonic units use radio waves to communicate with each other.

For maximum distance and noise-free operation, we recommend the following:

- Placing the product away from electrical appliances.
- Placing the base unit in a HIGH and CENTRAL location with no obstructions such as walls.
- Raising the antenna vertically.
- If you use the handset near a microwave oven which is being used, noise may be heard. Move away from the microwave oven and closer to the base unit.
- If you use the handset near another cordless phone's base unit, noise may be heard. Move away from the other cordless phone's base unit and closer to your base unit.

Environment

- Keep the product away from electrical noise generating devices, such as fluorescent lamps and motors.
- The product should be kept free from excessive smoke, dust, high temperature, and vibration.
- The product should not be exposed to direct sunlight.
- Do not place heavy objects on top of the product.
- When you leave the product unused for a long period of time, unplug the product from the power outlet.

- The product should be kept away from heat sources such as heaters, kitchen stoves, etc. It should not be placed in rooms where the temperature is less than 5 °C (41 °F) or greater than 40 °C (104 °F). Damp basements should also be avoided.
- The maximum calling distance may be shortened when the product is used in the following places: Near obstacles such as hills, tunnels, underground, near metal objects such as wire fences, etc.
- Operating near 2.4 GHz electrical appliances may cause interference. Move away from the electrical appliances.

Routine care

- Wipe the outer surface of the product with a soft moist cloth. Do not use benzine, thinner, or any abrasive powder.

Table of Contents

Introduction

About these operating instructions	7
Accessory information	8

Preparation

Setting up the base unit	10
Setting up the handset	11
Controls	13
Displays	16
Setting the unit before use	16

Making/Answering Calls

Making calls	17
Answering calls	18
Useful features during a call	18

Phonebook

Handset phonebook	20
Copying handset phonebook items	21

Caller ID Service

Using Caller ID service	22
Caller list	22

Programming

Programmable settings	24
---------------------------------	----

Voice Mail Service

Using Voice Mail service	28
------------------------------------	----

Multi-unit Operation

Handset locator	30
Intercom	30
Transferring calls between handsets, conference calls	31
Registering a handset	32

Useful Information

Wall mounting	33
Headset (optional)	34
Error messages	35
Troubleshooting	36

FCC and other information	39
Specifications	42
Warranty	43
Customer services	45

Index

Index	46
-----------------	----

About these operating instructions

These operating instructions can be used for KX-TG2620/KX-TG2621/KX-TG2622.

Descriptions of the multiple handsets and charger

KX-TG2622 includes 2 handsets and a charger. Descriptions of the multiple handsets and charger in these operating instructions are for KX-TG2622 only.

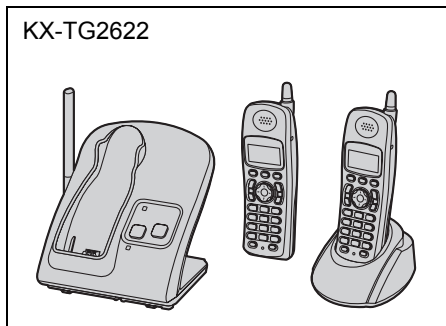

Symbols used in these operating instructions

Symbol	Meaning
Example: “Ringer volume”	Press [▲] or [▼] to select the words in quotations shown on the display.
→	Proceed to the next operation.
Example: [MENU] , [Phonebook]	The words in the brackets show button names including soft key names (page 16) on the handset and base unit.
Example: [MENU] → [0][5][1] → Select the desired setting. → [Save] → [OFF]	Press [MENU] , then press [0] , [5] , [1] . Press [▲] or [▼] to select the desired setting. Press [Save] , then press [OFF] .

Accessory information

Included accessories

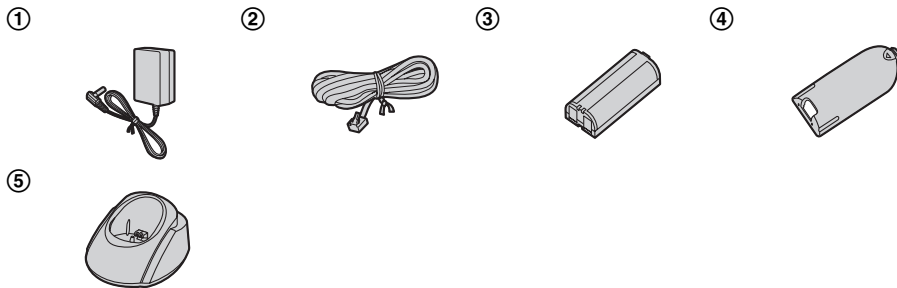

No.	Accessory item	Order number	Quantity			
			KX-TG 2620B	KX-TG 2620W	KX-TG 2621W	KX-TG 2622W
①	AC adaptor	PQLV19Y or PQLV255Z ^{*1}	1	1	1	2
②	Telephone line cord	PQJA10075Z	1	1	1	1
③	Battery	HHR-P105	1	1	1	2
④	Handset cover ^{*2}	PQYNTG2432BR	1	–	–	–
		PQYNTG2421WR	–	1	1	2
⑤	Charger	PQLV30041ZW	–	–	–	1

*1 Both of the AC adaptors function well with the base unit and charger.

*2 The handset cover comes attached to the handset.

Additional/replacement accessories

Accessory item	Order number
Rechargeable nickel metal hydride (Ni-MH) battery	HHR-P105
Headset	KX-TCA60, KX-TCA86, KX-TCA88HA, KX-TCA91, KX-TCA92, or KX-TCA98
T-adaptor	KX-J66
Battery back-up power supply	KX-TCA200

Accessory item	KX-TG2620B	KX-TG2620W/ KX-TG2621W/ KX-TG2622W
Belt clip	PQKE10393Z2	PQKE10393Z1

Sales and support information

- To order replacement accessories, call 1-800-332-5368.
- TTY users (hearing or speech impaired users) can call 1-866-605-1277.

Setting up the base unit

Connecting the AC adaptor and telephone line cord

Connect the telephone line cord until it clicks into the base unit (❶) and telephone line jack (❷). Connect the AC adaptor cord by pressing the plug firmly (❸).

- Use only the included Panasonic AC adaptor PQLV19 or PQLV255.

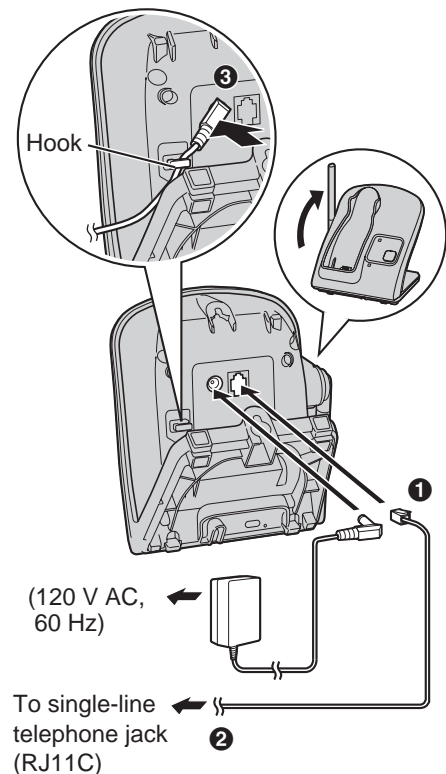

Note:

- The AC adaptor must remain connected at all times. (It is normal for the adaptor to feel warm during use.)
- The AC adaptor should be connected to a vertically oriented or floor-mounted AC outlet. Do not connect the AC adaptor to a ceiling-mounted AC outlet, as the weight of the adaptor may cause it to become disconnected.
- The unit will not work during a power failure. We recommend connecting a standard telephone to the same telephone line or to the same telephone jack using a Panasonic T-adaptor (page 9). Emergency power can be supplied to the unit by connecting a Panasonic battery back-up power supply noted on page 9.

If you subscribe to a DSL service

Please attach a noise filter (contact your DSL provider) to the telephone line between the base unit and the telephone line jack in the event of the following:

- Noise is heard during conversations.
- Caller ID features (page 22) do not function properly.

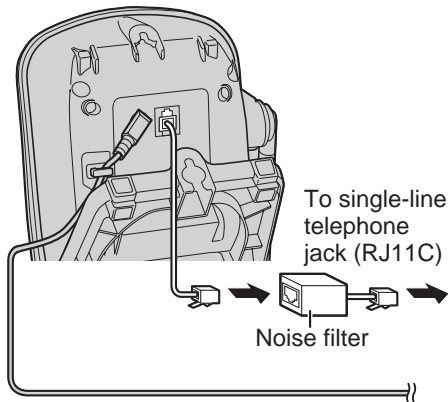

Setting up the handset

Connecting the charger

Available model:
KX-TG2622

- Use only the included Panasonic AC adaptor PQLV19 or PQLV255.

(120 V AC, 60 Hz)

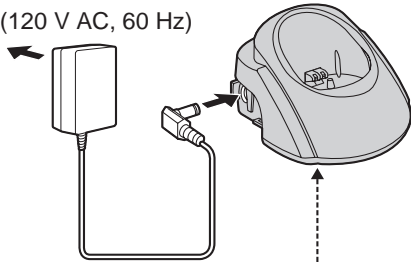

Bottom of the charger

Hooks

Fasten the AC adaptor cord to prevent it from being disconnected.

Battery installation/replacement

- 1 Press the notch of the handset cover firmly, and slide it in the direction of the arrow.
 - If necessary, remove the old battery.

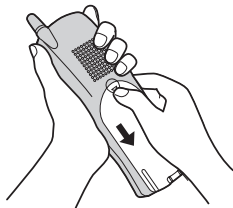

- 2 Insert the battery (1), and press it down until it snaps into position (2). Then close the handset cover.

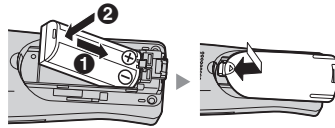

Important:

- Use only the rechargeable Panasonic battery noted on page 9.

Attention:



A nickel metal hydride battery that is recyclable powers the product you have purchased. Please call 1-800-8-BATTERY (1-800-822-8837) for information on how to recycle this battery.

Battery charge

Place the handset on the base unit or charger for **6 hours** before initial use. While charging, "Charging" is displayed and the CHARGE indicator on the base unit lights. When the battery is fully charged, "Charge completed" is displayed.



- Model shown is KX-TG2620.

Preparation

Charger:



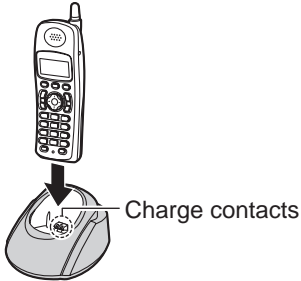

Available model:
KX-TG2622



Note:

- If you want to use the unit immediately, charge the battery for at least 15 minutes.
- To ensure that the battery charges properly, clean the charge contacts of the handset, base unit, and charger with a soft, dry cloth once a month. Clean more often if the unit is subject to the exposure of grease, dust, or high humidity.

Battery level

Battery icon	Battery level
	Fully charged
	Medium
	Low Flashing: needs to be recharged.
	Empty

Note:

- When the battery needs to be charged, the handset beeps intermittently while it is in use.

Panasonic battery performance

Operation	Operating time
While in use (talking)	Up to 5 hours
While not in use (standby)	Up to 11 days
While using the Clarity Booster feature (page 19)	Up to 3 hours

Note:

- Battery operating time may be shortened over time depending on usage conditions and surrounding temperature.
- Battery power is consumed whenever the handset is off the base unit or charger, even when the handset is not in use. Hence the longer you leave the handset off the base unit or charger, the less time you may actually talk using the handset.
- After the handset is fully charged, displaying "Charge completed", it may be left on the base unit (or charger) without any ill effect on the battery.
- The battery level may not be displayed correctly after you replace the battery. In this case, place the handset on the base unit (or charger) and let charge for 6 hours.

Controls

Base unit

KX-TG2620/KX-TG2621

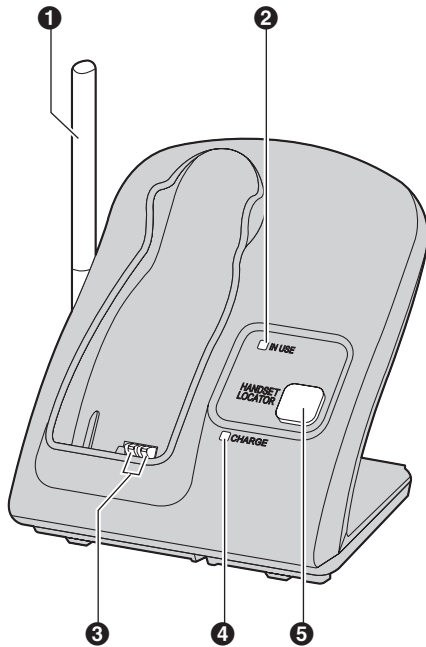

KX-TG2622

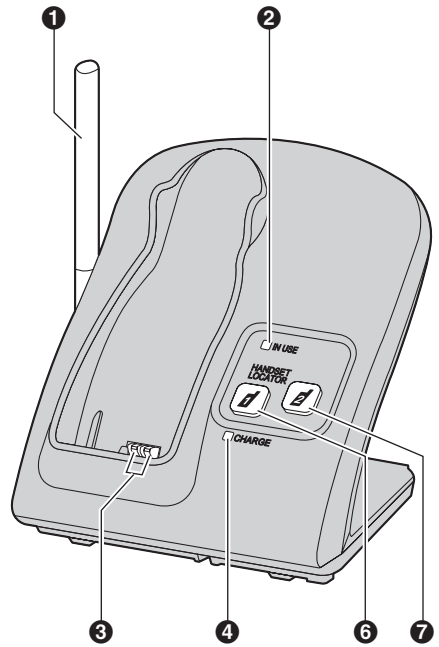

- ❶ Antenna
- ❷ IN USE indicator
- ❸ Charge contacts
- ❹ CHARGE indicator
- ❺ [HANDSET LOCATOR]
- ❻ [/] (HANDSET LOCATOR)
- ❼ [/] (HANDSET LOCATOR)

Preparation

Handset

KX-TG2620/KX-TG2622

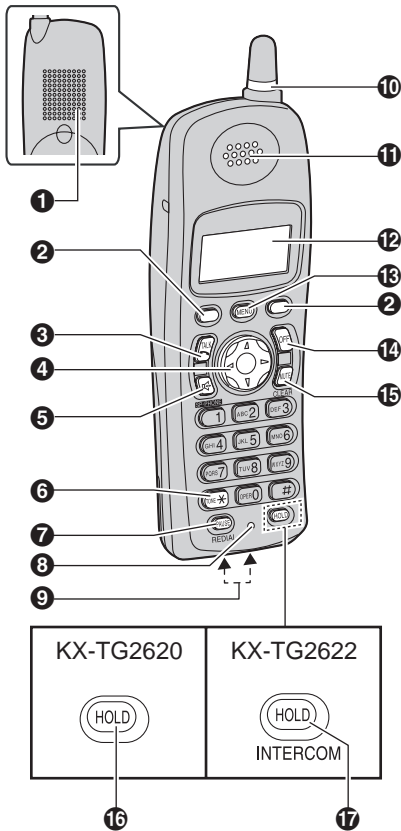

- 1 Speaker
- 2 Soft keys
- 3 [↶] (TALK)
- 4 Navigator key ([▲] [▼] [◀] [▶])
- 5 [☎] (SP-PHONE)
- 6 [*] (TONE)
- 7 [PAUSE] [REDIAL]
- 8 Microphone

- 9 Charge contacts
- 10 Ringer indicator
- Message indicator
- 11 Receiver
- 12 Display
- 13 [MENU]
- 14 [OFF]
- 15 [MUTE] [CLEAR]
- 16 [HOLD]
- 17 [HOLD] [INTERCOM]

Note:

- Some operations not mentioned above are displayed as soft key selections during operation (page 16).

Example: [Flash]

KX-TG2621

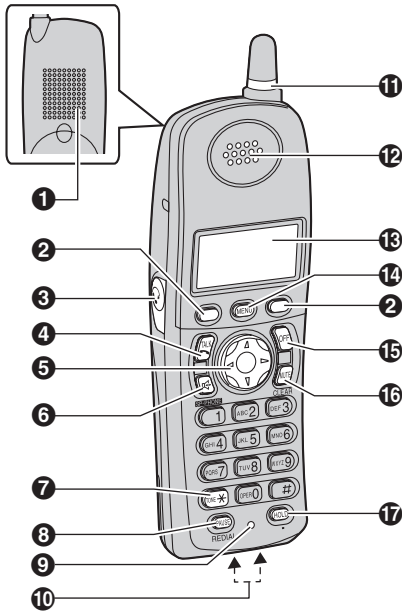

- 1 Speaker
- 2 Soft keys
- 3 Headset jack
- 4 [↶] (TALK)
- 5 Navigator key ([▲] [▼] [◀] [▶])
- 6 [☎] (SP-PHONE)
- 7 [*] (TONE)
- 8 [PAUSE] [REDIAL]
- 9 Microphone
- 10 Charge contacts
- 11 Ringer indicator
Message indicator
- 12 Receiver
- 13 Display
- 14 [MENU]

- 15 [OFF]
- 16 [MUTE] [CLEAR]
- 17 [HOLD]

Note:

- Some operations not mentioned above are displayed as soft key selections during operation (page 16).

Example: [Flash]

Using the navigator key

The handset navigator key can be used to navigate through menus and to select items shown on the display, by pressing [▲], [▼], [◀], or [▶].

Adjusting audio volume

Press [▲] or [▼] repeatedly while talking.

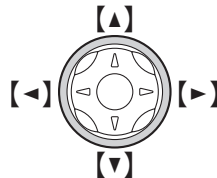

Preparation

Handset soft keys

The handset features 2 soft keys. By pressing a soft key, you can select the feature shown directly above it on the display.

[Select], **[Save]**, **[OK]**, **[Flash]** and additional other functions are assigned to soft keys, pay attention to soft keys to find functions you need during handset operation.

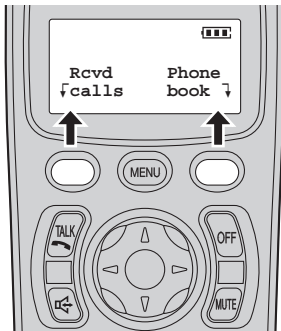

Note:

- In these operating instructions, soft key names are written inside brackets, the same way as other unit keys.

Example:



Unit keys: **[**, **[OFF]**, etc.

Soft keys: **[Rcvd calls]**, **[Phonebook]**, **[Flash]**, etc.

- Model shown is KX-TG2620.

Displays

Handset display items

Displayed item	Meaning
	Voice enhancer is on.
	Battery level

Setting the unit before use

Display language

The default setting is "English".

- 1 **[MENU]** → **[0][8]**
- 2 Select the desired setting.
- 3 Press the right soft key to save. → **[OFF]**

Dialing mode

If you cannot make calls, change this setting depending on your telephone line service. The default setting is "Tone".

"Tone": For tone dial service.

"Pulse": For rotary pulse dial service.

- 1 **[MENU]** → **[0][5][1]**
- 2 Select the desired setting. → **[Save]**
→ **[OFF]**

Making calls

- 1 Lift the handset and dial the phone number.
 - To correct a digit, press **[CLEAR]**.
- 2 Press **[↶]** or **[Call]**.
- 3 When you finish talking, press **[OFF]** or place the handset on the base unit or charger.

Note:

- “Line in use” is displayed when someone is talking on another handset (KX-TG2622) or another phone.

Using the speakerphone

- 1 Lift the handset, dial the phone number, and press **[☎]**.
 - Speak alternately with the other party.
- 2 When you finish talking, press **[OFF]**.

Note:

- Use the speakerphone in a quiet environment.
- To switch to the receiver, press **[↶]**.

Adjusting the receiver/speaker volume

Press **[▲]** or **[▼]** repeatedly while talking.

Making a call using the redial list

The last 5 phone numbers dialed are stored in the redial list.

- 1 **[REDIAL]**
- 2 Press **[▲]** or **[▼]** to select the desired number.
- 3 **[↶]**

Erasing a number in the redial list

- 1 **[REDIAL]**
- 2 Press **[▲]** or **[▼]** to select the desired number. → **[CLEAR]** → **[OFF]**

PAUSE button (for PBX/long distance service users)

A pause is sometimes required when making calls using a PBX or long distance service.

For example, if you need to dial the line access number “9” when making outside calls with a PBX:

- 1 **[9]** → **[PAUSE]** → Dial the phone number.
- 2 **[↶]**





Note:

- A 3.5 second pause is inserted each time **[PAUSE]** is pressed. Press repeatedly to insert longer pauses.

Answering calls

When a call is being received, the ringer indicator flashes rapidly.

1 Lift the handset and press [] or [].

- You can also answer the call by pressing any button except [], [], [], [], or [**OFF**]. (**Any key talk feature**)

2 When you finish talking, press [**OFF**].

Note:

- You can change the ringer tone. You can also adjust the ringer volume (page 26).

Auto talk

This feature allows you to answer a call by simply lifting the handset off the base unit or charger. You do not need to press []. To activate this feature, see page 26.

Temporary ringer off

While the handset is ringing for an outside call, you can turn the ringer off temporarily by pressing [**OFF**].

Useful features during a call

HOLD button

This feature allows you to put an outside call on hold.

KX-TG2620/KX-TG2621

Press [**HOLD**] during an outside call.

- To release the hold, press [].

Note:



- If another phone is connected on the same line (page 10), you can also take the call by lifting its handset.
- If a call is kept on hold for more than 6 minutes, an alarm tone starts to sound. After 4 additional minutes on hold, the call is disconnected.

KX-TG2622

1 Press [**HOLD**] during an outside call.

- To transfer the call to another handset, continue from step 2 on page 31, “Transferring calls between handsets, conference calls”.

2 Press [**HOLD**] again.

- To release the hold, press [].
- Another handset user can take the call by pressing [].

Note:

- If another phone is connected on the same line (page 10), you can also take the call by lifting its handset.
- If a call is kept on hold for more than 6 minutes, an alarm tone starts to sound. After 4 additional minutes on hold, the call is disconnected.

Mute

While mute is turned on, you can hear the other party, but the other party cannot hear you.

To mute your voice, press **[MUTE]**.

- To return to the conversation, press **[MUTE]** or **[↶]**.

FLASH button

Pressing **[Flash]** allows you to use special features of your host PBX such as transferring an extension call, or accessing optional telephone services such as Call Waiting.

Note:

- To change the flash time, see page 27.
- **[Flash]** is a soft key visible on the handset display during a call.

For Call Waiting service users

To use Call Waiting, you must subscribe to your telephone company's Call Waiting service.

This feature allows you to receive calls while you are already talking on the phone. If you receive a call while on the phone, you will hear a Call Waiting tone. Please contact your telephone company for details and availability of this service in your area.

Press **[Flash]** to answer the 2nd call.

- To switch between calls, press **[Flash]**.

Temporary tone dialing (for rotary/pulse service users)

You can temporarily switch the dialing mode to tone when you need to access touch tone services (for example, answering services, telephone banking services, etc.).

Press **[✳]** (TONE) before entering access numbers which require tone dialing.

Handset clarity booster

This feature can improve sound clarity when the handset is used in an area where there may be interference. During an outside call, this feature is turned on automatically when necessary. You can also turn this feature on or off manually.

- 1 Press **[MENU]** during an outside call.
- 2 Press **[2]** to select "Booster on" or "Booster off".

Note:

- When this feature is turned off manually during a call, it does not turn on again automatically during the same call.
- While this feature is turned on, the battery operating time is shortened (page 12).

Handset voice enhancer

This feature clarifies the voice of the person you are talking to, reproducing a more natural-sounding voice that is easier to hear and understand (page 24).

- 1 Press **[MENU]** during an outside call.
- 2 Press **[3]** to select "V.E. on" or "V.E. off".

Note:

- When turned on, **(VE)** will be displayed.
- Depending on the condition and quality of your telephone line, this feature may emphasize existing line noise. If it becomes difficult to hear, turn this feature off.

Call share

Available model:
KX-TG2622

This feature allows the handset to join an existing outside call.
To join the conversation, press **[↶]** when the other handset is on an outside call.

Handset phonebook

You can add up to 50 items to the handset phonebook and search for phonebook items by name.

Adding items to the phonebook

1 [Phonebook]

2 [Add]

3 Enter the name (max. 16 characters).
→ [Next]

4 Enter the phone number (max. 32 digits). → [Next] → [Save]
• To add other items, repeat from step 2.

5 [OFF]

Character table

Key	Character
[1]	& ' () , - . / 1
[2]	a b c A B C 2
[3]	d e f D E F 3
[4]	g h i G H I 4
[5]	j k l J K L 5
[6]	m n o M N O 6
[7]	p q r s P Q R S 7
[8]	t u v T U V 8
[9]	w x y z W X Y Z 9
[0]	0 Space
[*]	*
[#]	#

- To enter another character that is located on the same dial key, first press [▶] to move the cursor to the next space.

Editing/correcting a mistake

Press [◀] or [▶] to move the cursor to the character or number you want to erase, then press [CLEAR]. Enter the appropriate character or number.

- Press and hold [CLEAR] to erase all characters or numbers.

Finding and calling a phonebook item

Phonebook items can be searched for alphabetically by scrolling through the phonebook items or by entering the first initial.

Searching for a name alphabetically by scrolling through all items

1 [Phonebook] → [Search]

2 Press [▲] or [▼] to select the desired item.

3 Press [↵] to dial the phone number.

Searching for a name by initial

- 1 **[Phonebook]** → **[Search]**
- 2 Press the dialing button (**[0]** to **[9]**, **[#]**, or **[*]**) that corresponds to the first letter you are searching for (see the character table, page 20).
Example: "LISA"
 Press **[5]** repeatedly to display the first phonebook entry starting with the initial "L" and go to step 3.
 - If there is no item corresponding to the letter you selected, the next item is displayed.
- 3 Press **[v]** to select the desired item.
- 4 Press **[↶]** to dial the phone number.

Editing items in the phonebook

- 1 Find the desired item (page 20, 21). → **[Edit]**
- 2 Edit the name if necessary (see the character table, page 20). → **[Next]**
- 3 Edit the phone number if necessary. → **[Next]** → **[Save]** → **[OFF]**

Erasing items in the phonebook

- 1 Find the desired item (page 20, 21).
- 2 **[CLEAR]** → **[Yes]** → **[OFF]**

Chain dial

This feature allows you to dial phone numbers in the handset phonebook while you are on a call. This feature can be used, for example, to dial a calling card access number or bank account PIN that you have stored in the handset phonebook, without having to dial manually.

- 1 During an outside call, press **[MENU]**.
- 2 "Phonebook" → **[Select]**
- 3 Find the desired item (page 20, 21). → **[Call]**

Note:

- When storing a calling card access number and your PIN in the phonebook as one phonebook item, press **[PAUSE]** to add pauses after the number and PIN as necessary (page 21).
- If you have rotary or pulse service, you need to press **[*]** before pressing **[MENU]** in step 1 to change the dialing mode temporarily to tone.

Copying handset phonebook items

Available model:
KX-TG2622

You can copy one or all of the phonebook items from one handset to another.

Copying an item

- 1 **[MENU]** → **[#][1]**
- 2 Press **[▲]** or **[v]** to select the desired item. → **[Send]**
- 3 Press **[OFF]** after the long beep.

Copying all items

- 1 **[MENU]** → **[#][2]**
- 2 Press **[OFF]** after the long beep

Using Caller ID service

This unit is Caller ID compatible. To use Caller ID features, you must subscribe to your telephone company's Caller ID service.

Caller ID features

When an outside call is being received, the calling party's name and telephone number are displayed.

Caller information for the last 50 different callers is logged in the caller list by the most recent call to the oldest.

- Generally caller information is displayed from the 2nd ring.
- If the unit cannot receive caller information, the following is displayed:
 - “**Out of area**”: The caller dialed from an area which does not provide Caller ID service.
 - “**Private caller**”: The caller requested not to send caller information.
 - “**Long distance**”: The caller called you long distance.
- If the unit is connected to a PBX system, caller information may not be received properly. Consult your PBX supplier.

Missed calls

If a call is not answered, the unit treats the call as a missed call. The number of missed calls is shown on the handset display. This lets you know if you should view the caller list to see who called while you were out.

Private name display

When caller information is received and it matches a phone number stored in the phonebook, the stored name is displayed and logged in the caller list.

Call Waiting Caller ID display

If you subscribe to both Caller ID and Call Waiting with Caller ID services, the 2nd caller's information is displayed after you hear a Call Waiting tone (page 19). Please contact your telephone company for details and availability of this service in your area.

Caller list

Viewing the caller list and calling back

- 1** Press [**▲**] or [**▼**] to enter the caller list
- 2** Press [**▼**] to search from the most recent call, or [**▲**] to search from the oldest call.
- 3** [**↶**]

Note:

- **KX-TG2622:**
 - Each handset has its own caller list. If you viewed the caller list or answered a call on one handset, the same information in the other handsets is displayed as “**missed calls**”.
- You can also press [**Rcvd calls**] to enter the caller list.
- If the same caller calls more than once, it is displayed with the number of times the caller called (“x2” to “x9”). Only the date and time of the most recent call is stored.
- A ✓ is displayed next to items which have already been viewed or answered.

Editing a caller's phone number before calling back

You can edit a phone number in the caller list by removing its area code and/or the long distance code "1".

- 1 Press **[▲]** or **[▼]** to enter the caller list.
- 2 Select the desired item.
- 3 Press **[Edit]** repeatedly until the phone number is shown in the desired format.

- ① Local phone number

Example:

- ② Area code – Local phone number

Example:

- ③ 1 – Area code – Local phone number

Example:

4 **[↶]**

Caller ID number auto edit feature

Once you call back an edited number, the unit can automatically edit other incoming phone numbers each time you receive a call.

For example, you can use this feature to set the unit to ignore the area code of callers in your area code, so that you can call these local numbers using caller information without dialing the area code. To activate this feature, you must edit an item in the caller list, then call that number. After that, phone numbers from that caller's area code are edited automatically. This feature can be turned on or off (page 26).

Note:

- Phone numbers from the 4 most recently edited area codes are automatically edited.
- If you move to another area, you can turn this feature off to erase previously edited area codes. To use this feature again, turn it on and reprogram the area codes you want to edit once again.

Storing caller information into the phonebook

- 1 Press **[▲]** or **[▼]** to enter the caller list.
- 2 Select the desired item.
 - To edit the number, press **[Edit]** repeatedly until the phone number is shown in the desired format.

3 **[Save]**

- If there is the name information for the caller, skip to step 5.

- 4 Enter the name (see the character table, page 20). → **[Next]** → **[Save]**

5 **[OFF]**

Erasing selected caller information

- 1 Press **[▲]** or **[▼]** to enter the caller list.
- 2 Select the desired item.
- 3 **[CLEAR]** → **[OFF]**

Erasing all caller information

- 1 Press **[▲]** or **[▼]** to enter the caller list.
- 2 **[All erase]** → **[Yes]**

Programmable settings

You can customize the unit by programming the following features using the handset. To access the features, there are 2 methods: scrolling through the display menus (page 24) or using the direct commands (page 26).

- Mainly the direct command method is used in these operating instructions.

Programming by scrolling through the display menus

1 [MENU]

2 Press [▲] or [▼] to select the desired menu. → [Select]

- If there is a sub-menu(s), press [▲] or [▼] to select the desired item. → [Select]

Example: To access the handset ringer tone setting

Press [▲] or [▼] to select "Ringer setting". → [Select]

Then press [▲] or [▼] to select "Ringer tone". → [Select]

3 Press [▲] or [▼] to select the desired setting.

- This step may vary depending on the feature being programmed.

4 [Save] → [OFF]

Main menu	Sub-menu 1	Sub-menu 2	Page
V.M. access	–	–	page 29
Ringer setting	Ringer volume	–	–
	Ringer tone	–	–
	Interrupt tone ^{*1}	–	–
Voice enhancer	–	–	–
Copy phonebook ^{*1}	Copy 1 item	–	page 21
	Copy all items	–	page 21
Customer support	–	–	page 27

Main menu	Sub-menu 1	Sub-menu 2	Page
Initial setting	Voice Mail	Store VM access# ^{*2}	page 28
		VM tone detect ^{*2}	page 28
	Message alert	–	page 29
	LCD contrast	–	–
	Key tone	–	–
	Auto talk	–	–
	Caller ID edit	–	–
	Set tel line	Set dial mode ^{*2}	page 16
		Set flash time ^{*2}	–
		Set line mode ^{*2}	–
	Registration	–	page 32
	Change language	–	page 16

*1 KX-TG2622

*2 If you program these settings using one of the handsets, you do not need to program the same item using another handset (KX-TG2622).

Programming using the direct commands

1 [MENU]

2 Enter the desired feature code.

3 Enter the desired setting code.

- This step may vary depending on the feature being programmed.

4 [Save] → [OFF]

Note:

- In the following table:
 - < > shows the default setting.
 - If “System setting” column is checked, you do not need to program the same item using another handset (KX-TG2622).
- If you make a mistake or enter the wrong code, press [OFF], then start again by pressing [MENU].

Feature	Feature code	Setting code	System setting
Auto talk ^{*1}	[0][3]	[1]: On [0]: <Off>	–
Caller ID edit (Caller ID number auto edit)	[0][4]	[1]: <On> [0]: Off (page 22)	–
Change language (Display language)	[0][8]	[1]: <English> [2]: Español (page 16)	–
Copy phonebook (1 item) ^{*2}	[#][1]	(page 21)	–
Copy phonebook (All items) ^{*2}	[#][2]	(page 21)	–
Interrupt tone ^{*3}	[1][3]	[1]: On [2]: <2> [0]: Off	–
Key tone ^{*4}	[0][2]	[1]: <On> [0]: Off	–
LCD contrast (Display contrast)	[0][1]	[1]–[6]: Level 1–6 <3>	–
Message alert	[0] [#]	[1]: On [0]: <Off>	–
Registration	[0][0]	(page 32)	–
Ringer tone (Handset) ^{*5}	[1][2]	[1]–[3]: Tone <1>–3 [4]–[7]: Melody 1–4	–
Ringer volume (Handset)	[1][1]	[1]: Low [2]: Medium [3]: <High> [0]: Off	–
Set dial mode	[0][5][1]	[1]: Pulse [2]: <Tone> (page 16)	●

Feature	Feature code	Setting code	System setting
Set flash time ^{*6}	[0][5][2]	[1]: <700ms> [2]: 600ms [3]: 400ms [4]: 300ms [5]: 250ms [6]: 110ms [7]: 100ms [8]: 90ms	●
Set line mode ^{*7}	[0][5][3]	[1]: A [2]: 	●
Store VM access#	[0][7][1]	Go to step 2 on page 28.	●
V.M. access	[3]	Go to step 2 on page 29.	–
VM tone detect	[0][7][2]	[1]: <On> [0]: Off	●
Voice enhancer	[5]	[1]: On [0]: <Off>	–

*1 If you subscribe to Caller ID service and want to view the caller's information after lifting up the handset to answer a call, turn off this feature.

*2 KX-TG2622

*3 This tone lets you know when you receive a call while you are on an intercom call. If you select "On", the tone sounds repeatedly for as long as the line rings. If you select "2", the tone only sounds 2 times. (KX-TG2622)

*4 You can select whether or not key tones are heard when keys are pressed. Includes confirmation tones and error tones.

*5 If you subscribe to a distinctive ring service (such as IDENT-A-RING), select a tone (tone 1 to 3). If you select a melody, you cannot distinguish lines by their ringers.

*6 The flash time depends on your telephone exchange or host PBX. Consult your PBX supplier if necessary. The setting should stay at "700ms" unless pressing **[Flash]** fails to pick up the call waiting call.

*7 Generally, the line mode setting should not be adjusted. If "Line in use" is not displayed when another phone connected to the same line is in use, you need to change the line mode to "A".

Customer support

The handset can display the Internet address where you can download the operating instructions or get further information for this product using your computer.

[MENU] → "Customer support" → **[Select]** → **[OFF]**

Using Voice Mail service

Voice Mail is an automatic answering service offered by your telephone service provider. After you subscribe to this service, the telephone service provider's Voice Mail system will answer calls for you when you are unavailable to answer the phone or when your line is busy. Messages are recorded by the telephone service provider, not your telephone.

Important:

- Please contact your telephone service provider for details and availability of this service in your area.

Storing the Voice Mail (VM) access number

In order to listen to your Voice Mail messages, you must dial your telephone service provider's Voice Mail access number. Once you have stored your Voice Mail access number, you can dial it automatically (page 29).

1 [MENU] → [0][7][1]

2 Enter your access number (max. 32 digits). → [Save] → [OFF]

Note:

- When storing your Voice Mail access number and your mailbox password, press [PAUSE] to add pauses (page 18) between the access number and the password as necessary. Consult your telephone service provider for the required pause time.

Example:

1-222-333-4444	PPPP	8888
VM access number	Pauses	Password

To erase the Voice Mail access number

Repeat step 1, then press and hold [CLEAR] until all digits are erased. Press [Save], then press [OFF].

Voice Mail (VM) tone detection

Your telephone service provider sends special signals (sometimes called "Voice Mail tones" or "stutter tones") to the unit to let you know you have new Voice Mail messages. If you hear a series of dial tones followed by a continuous dial tone after you press [📞], you have new Voice Mail messages. Minutes after you hang up a call or after the phone stops ringing, your unit will check the phone line to see if new Voice Mail messages have been recorded. Turn this feature off when:

- You do not subscribe to Voice Mail service.
- Your telephone company does not send Voice Mail tones.
- Your phone is connected to a PBX.

If you are not sure which setting is required, consult your telephone service provider.

Turning VM detection on/off

The default setting is "on".

1 [MENU] → [0][7][2]

2 Select the desired setting. → [Save] → [OFF]

Listening to Voice Mail messages

The unit lets you know that you have new Voice Mail messages in the following ways:

- “Voice Mail” is displayed on the handset.
- The message indicator on the handset flashes slowly if message alert feature is turned on.

1 Press [**↶**], then press [**VM**] within 15 seconds.

- If [**VM**] is not displayed, the Voice Mail access number has not been stored. Store the number (page 28).

OR

[**MENU**] → “v.m. access” → [**Select**]

- The speakerphone turns on.

2 Follow the prerecorded instructions.

3 Press [**OFF**] when finished.

Note:

- If “Voice Mail” still remains on the display even after you have listened to new messages, turn it off by pressing and holding [**OFF**] until the handset beeps.
- If your Voice Mail service uses Voice Mail tones and the message is over 3 minutes long, the handset may not indicate new messages.

- If your Voice Mail service uses Voice Mail tones, the tones are heard from any phone connected to the same line. If you want to use another phone to listen to Voice Mail messages, you have to dial your access number manually.

Message alert

Message alert controls the message indicator on the handset once it turns on, message indicator will flash slowly when there are new recorded messages in the Voice Mail system.

1 [**MENU**] → [**0**][**#**]

2 Select the desired setting. → [**Save**] → [**OFF**]

Note:





- While message alert is on, battery operating time is shortened.

Handset locator

KX-TG2620/KX-TG2621

- 1 Base unit:**
[HANDSET LOCATOR]
 - The handset beeps for 1 minute.
- 2 Base unit:**
To stop paging, press **[HANDSET LOCATOR]**.
Handset:
To stop paging, press **[OFF]**.

KX-TG2622

- 1 Base unit:**
[] or **[]**
 - The handset beeps for 1 minute.
- 2 Base unit:**
To stop paging, press **[]** or **[]**.
Handset:
To stop paging, press **[OFF]**.

Intercom

Available model: KX-TG2622

Intercom calls can be made between 2 handsets.

Note:

- If you receive a phone call while talking on the intercom, you hear 2 tones (page 26). To answer the call, press **[OFF]**, then press [].

Making an intercom call

- 1 [INTERCOM]**
 - The destination handset beeps for 1 minute.
- 2** To end the intercom call, press **[OFF]**.

Answering an intercom call

- 1** Press [] to answer the page.
- 2** To end the intercom call, press **[OFF]**.

Note:

- When the ringer volume is set to off, the handset rings at the low level for intercom calls.

Transferring calls between handsets, conference calls

Available model:
KX-TG2622

Outside calls can be transferred between 2 handsets. 2 handsets can have a conference call with an outside party.

- 1** During an outside call, press **[INTERCOM]** to put the call on hold.
- 2** Press the right soft key.
- 3** Wait for the paged party to answer.
 - If the paged party does not answer, press **[↶]** to return to the outside call.
- 4** To complete the transfer, press **[OFF]**.
 - The outside call is being routed to another handset.To establish a conference call, press **[Conf]**.
 - To leave the conference, press **[OFF]**. The other parties can continue the conversation.
 - To put the outside call on hold, press **[HOLD]**. To resume the conference, press **[Conf]**.

Transferring a call without speaking to the paged party

- 1** During an outside call, press **[INTERCOM]**, then press the right soft key.
- 2** Press **[OFF]**.
 - The outside call rings at the other handset.

Note:

- If the paged party does not answer the call, press **[↶]** to return to the call. If not answered within 1 minute, the call will ring at your handset again. If you still do not answer the call within 4 minutes, the call will be disconnected.

Answering transferred calls

Press **[↶]** to answer the page.

- After the paging party disconnects, you can talk to the outside caller.

Registering a handset

The included handset and base unit are preregistered. If for some reason the handset is not registered to the base unit, register the handset.

KX-TG2620/KX-TG2621

1 Handset:

[MENU] → [0][0]

2 Base unit:

Press and hold **[HANDSET LOCATOR]** until the CHARGE indicator flashes.

- After the CHARGE indicator starts flashing, the rest of the procedure must be completed within 1 minute.

3 Handset:

Press **[OK]**, then wait until the handset beeps.

KX-TG2622

Important:

- If you accidentally assign another handset's extension number to the base unit, the originally assigned handset stops functioning. Confirm the extension number of the handset by placing it on the base unit or charger. Lift the handset from the charger before registering.

1 Handset:

[MENU] → [0][0]

2 Base unit:

Press and hold **[↗]** or **[↘]** until the CHARGE indicator flashes.

- After the CHARGE indicator starts flashing, the rest of the procedure must be completed within 1 minute.

3 Handset:

Press **[OK]**, then wait until the handset beeps.

Wall mounting

Base unit

Connect the telephone line cord. Mount the unit by inserting the mounting pins into the round openings on the adaptor (for pin **B**), use round cut out at the bottom of the adaptor if you are using the 4 inches phone plate), then sliding the unit down to secure it.

Connect the AC adaptor to power outlet (page 10).

- There are two common types of wall phone plates. The distance between **A** and **B** may vary depending on the size of the wall phone plate installed.

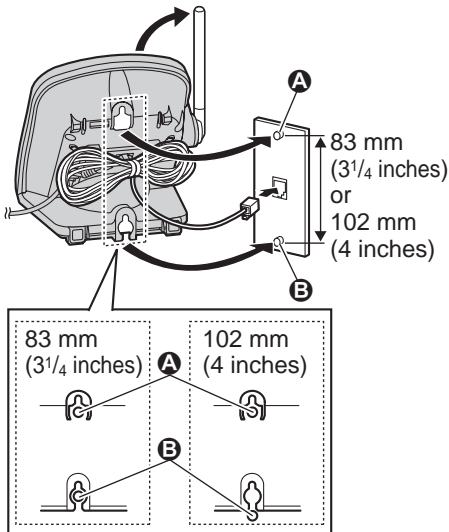

Charger

Available model:

KX-TG2622

- 1 Drive the screws (not included) into the wall using the wall template as a guide.

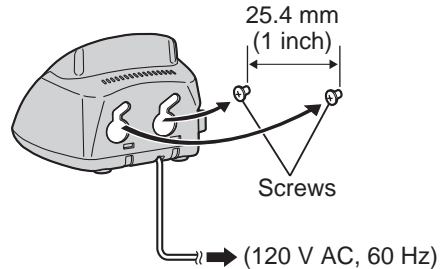

- 2 Mount the charger (1), then slide it down (2) and to the right (3) until it is secure.

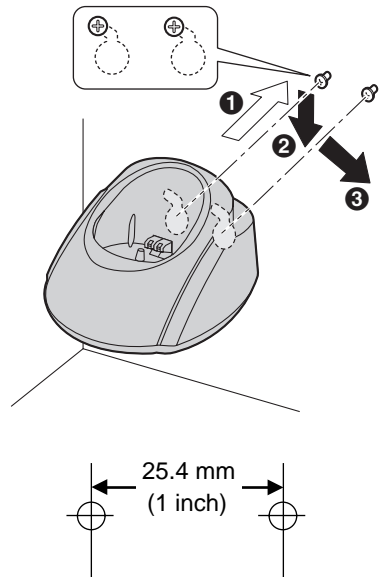

Headset (optional)

Available model:

KX-TG2621

Connecting a headset to the handset allows hands-free phone conversations. Please use only a Panasonic headset (page 9).

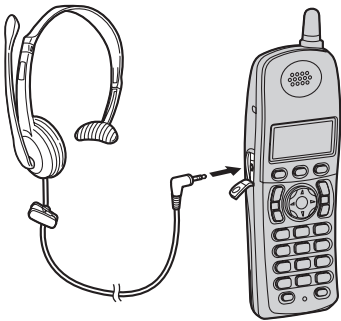

- Headset shown is KX-TCA86.

Switching a call between the headset and speakerphone

To switch to the speakerphone, press [📞].

To return to the headset, press [📞].

Error messages

If the unit detects a problem, one of the following messages is shown on the display.

Display message	Cause/solution
Busy	<ul style="list-style-type: none"> ● Another handset or the called handset is in use.*1 ● The handset you tried to copy phonebook items to is in use.*1 ● The handset you are calling is too far from the base unit.*1
Error!!	<ul style="list-style-type: none"> ● The handset's registration has failed. Move the handset and base unit away from all electrical appliances and try again. ● Another handset user tried to send phonebook items to you but there was an error. Have the other handset user re-send the items to you (page 20).*1
---Incomplete--- Phonebook full	<ul style="list-style-type: none"> ● The destination unit's phonebook memory is full. Erase unnecessary items from the destination unit's phonebook (page 21).*1
Invalid	<ul style="list-style-type: none"> ● The other handset is not registered.*1
No items stored	<ul style="list-style-type: none"> ● Your phonebook or redial list is empty.
No link to base. Move closer to base, try again.	<ul style="list-style-type: none"> ● The handset has lost communication with the base unit. Move closer to the base unit, and try again. ● Confirm that the base unit's AC adaptor is plugged in. ● Raise the base unit antenna. ● The handset's registration may have been canceled. Re-register the handset (page 32).
Phonebook full	<ul style="list-style-type: none"> ● There is no space to store new items in the phonebook. Erase unnecessary items (page 23).
Please lift up and try again.	<ul style="list-style-type: none"> ● A handset button was pressed while the handset was on the base unit or charger. Lift the handset and press the button again.
System is busy. Please try again later.	<ul style="list-style-type: none"> ● Other units are in use and the system is busy. Try again later.*1
Store VM access#	<ul style="list-style-type: none"> ● You have not stored the Voice Mail access number. Store the number (page 28).

*1 KX-TG2622

Troubleshooting



General use

Problem	Cause/solution
The unit does not work.	<ul style="list-style-type: none">● Make sure the battery is installed correctly and fully charged (page 12).● Check the connections (page 11).● Unplug the base unit's AC adaptor to reset the unit. Reconnect the adaptor and try again.● The handset has not been registered to the base unit. Register the handset (page 32).
I cannot hear a dial tone.	<ul style="list-style-type: none">● Confirm the telephone line cord is properly connected (page 10).● Disconnect the unit from the telephone line and connect a known working telephone. If the working telephone operates properly, contact our service personnel to have the unit repaired. If the working telephone does not operate properly, contact your telephone company.

Programmable settings

Problem	Cause/solution
While programming, the handset starts to ring.	<ul style="list-style-type: none">● A call is being received. Answer the call and start again after hanging up.



Battery recharge

Problem	Cause/solution
I charged the battery fully, but  continues to flash, or  is displayed.	<ul style="list-style-type: none">● Clean the charge contacts and charge again (page 12).● The battery may need to be replaced with a new one (page 12).
The handset display is blank.	<ul style="list-style-type: none">● Confirm that the battery is properly installed.● Fully charge the battery (page 12).

Making/answering calls, intercom

Problem	Cause/solution
Static is heard, sound cuts in and out. Interference from other electrical units.	<ul style="list-style-type: none"> ● Move the handset and the base unit away from other electrical appliances. ● Move closer to the base unit. ● Raise the base unit antenna. ● Turn on the clarity booster feature (page 19). ● If your unit is connected to a telephone line with DSL service, we recommend connecting a noise filter between the base unit and the telephone line jack. Contact your DSL provider for details.
The handset does not ring.	<ul style="list-style-type: none"> ● The ringer volume is turned off. Adjust it (page 26).
I cannot make a call.	<ul style="list-style-type: none"> ● The dialing mode may be set incorrectly. Change the setting (page 16). ● The base unit or another handset is in use. Try again later. (KX-TG2622)
I cannot redial by pressing [REDIAL] .	<ul style="list-style-type: none"> ● If the last number dialed was more than 48 digits long, the number will not be redialed correctly. Dial the number manually.
I cannot have a conversation using the headset. (KX-TG2621)	<ul style="list-style-type: none"> ● Make sure that an optional headset is connected properly (page 34). ● If “SP-phone” is displayed on the handset, press [] to switch to the headset.
I cannot make long distance calls.	<ul style="list-style-type: none"> ● Make sure that you have long distance service.
I cannot page the handset.	<ul style="list-style-type: none"> ● The called handset is too far from the base unit. ● The called handset is in use. Try again later.

Phonebook

Problem	Cause/solution
Copying stopped with an item displayed. (KX-TG2622)	<ul style="list-style-type: none"> ● The destination handset may have lost communication with the base unit, or the destination unit user may have pressed [] or []. The displayed phonebook item was not copied to the unit. Press [OFF]. Confirm that the destination unit is not in use and try again.

Useful Information

Caller ID

Problem	Cause/solution
The handset does not display the caller's name and/or phone number.	<ul style="list-style-type: none">● You have not subscribed to Caller ID service. Contact your telephone company to subscribe.● If your unit is connected to any additional telephone equipment such as a Caller ID box or cordless telephone jack, disconnect the unit from the equipment and plug the unit directly into the wall jack.● If your unit is connected to a telephone line with DSL service, we recommend connecting a noise filter between the base unit and the telephone line jack. Contact your DSL provider for details.● The name display service may not be available in some areas. Contact your telephone company for details.● Other telephone equipment may be interfering with this unit. Disconnect the other equipment and try again.● The caller requested not to send caller information (page 22).● If a call is being transferred to you, the caller information is not displayed.
The caller list/incoming phone numbers are not edited automatically.	<ul style="list-style-type: none">● The Caller ID number auto edit feature is turned off. Turn it on and try again (page 26).● You need to call back the edited number to activate Caller ID number auto edit.
I cannot dial the phone number edited in the caller list.	<ul style="list-style-type: none">● The phone number you dialed might have an incorrectly edited pattern (for example, the long distance "1" or the area code is missing). Edit the phone number with another pattern (page 23).
The 2nd caller's information is not displayed during an outside call.	<ul style="list-style-type: none">● In order to use Caller ID, Call Waiting, or Call Waiting Caller ID (CWID), you must first contact your telephone company and subscribe to the desired service. After subscribing, you may need to contact your telephone company again to activate this specific service, even if you already subscribed to both Caller ID and Call Waiting with Caller ID services (CWID).

FCC and other information

This equipment complies with Part 68 of the FCC rules and the requirements adopted by the ACTA. On the bottom of this equipment is a label that contains, among other information, a product identifier in the format US:ACJ-----.

If requested, this number must be provided to the telephone company.

- Registration No
.....(found on the bottom of the unit)
- Ringer Equivalence No.
(REN).....0.1B

A plug and jack used to connect this equipment to the premises wiring and telephone network must comply with the applicable FCC Part 68 rules and requirements adopted by the ACTA. A compliant telephone cord and modular plug is provided with the product. It is designed to be connected to a compatible modular jack that is also compliant.

The REN is used to determine the number of devices that may be connected to a telephone line. Excessive RENs on a telephone line may result in the devices not ringing in response to an incoming call. In most but not all areas, the sum of RENs should not exceed five (5.0). To be certain of the number of devices that may be connected to a line, as determined by the total RENs, contact the local telephone company. For products approved after July 23, 2001, the REN for the product is part of the product identifier that has the format US:AAAEQ##TXXXX. The digits represented by ## are the REN without a

decimal point (e.g., 03 is a REN of 0.3).

If this equipment causes harm to the telephone network, the telephone company will notify you in advance that temporary discontinuance of service may be required. But if advance notice isn't practical, the telephone company will notify the customer as soon as possible. Also, you will be advised of your right to file a complaint with the FCC if you believe it is necessary.

The telephone company may make changes in its facilities, equipment, operations or procedures that could affect the operation of the equipment. If this happens the telephone company will provide advance notice in order for you to make necessary modifications to maintain uninterrupted service.

If trouble is experienced with this equipment, for repair or warranty information, please contact a Factory Servicenter or other Authorized Servicer. If the equipment is causing harm to the telephone network, the telephone company may request that you disconnect the equipment until the problem is resolved.

Connection to party line service is subject to state tariffs. Contact the state public utility commission, public service commission or corporation commission for information.

If your home has specially wired alarm equipment connected to the telephone

Useful Information

line, ensure the installation of this equipment does not disable your alarm equipment. If you have questions about what will disable alarm equipment, consult your telephone company or a qualified installer.

This equipment is hearing aid compatible as defined by the FCC in 47 CFR Section 68.316.

When you hold the phone to your ear, noise might be heard in your Hearing Aid. Some Hearing Aids are not adequately shielded from external RF (radio frequency) energy. If noise occurs, use an optional headset accessory or the speakerphone option (if applicable) when using this phone. Consult with your audiologist or Hearing Aid manufacturer about the availability of Hearing Aids which provide adequate shielding to RF energy commonly emitted by digital devices.

WHEN PROGRAMMING EMERGENCY NUMBERS AND/OR MAKING TEST CALLS TO EMERGENCY NUMBERS:

- 1) Remain on the line and briefly explain to the dispatcher the reason for the call.
- 2) Perform such activities in the off-peak hours, such as early morning or late evenings.

This device complies with Part 15 of the FCC Rules. Operation is subject to the following two conditions:

(1) This device may not cause harmful interference, and (2) this device must accept any interference received, including interference that may cause undesired operation.

Privacy of communications may not be ensured when using this phone.

CAUTION:

Any changes or modifications not expressly approved by the party responsible for compliance could void the user's authority to operate this device.

NOTE:

This equipment has been tested and found to comply with the limits for a Class B digital device, pursuant to Part 15 of the FCC Rules. These limits are designed to provide reasonable protection against harmful interference in a residential installation. This equipment generates, uses, and can radiate radio frequency energy and, if not installed and used in accordance with the instructions, may cause harmful interference to radio communications. However, there is no guarantee that interference will not occur in a particular installation. If this equipment does cause harmful interference to radio or television reception, which can be determined by turning the equipment off and on, the user is encouraged to try to correct the interference by one or more of the following measures:

- Reorient or relocate the receiving antenna.
- Increase the separation between the equipment and receiver.
- Connect the equipment into an outlet on a circuit different from that to which the receiver is connected.
- Consult the dealer or an experienced radio/TV technician for help.

Some cordless telephones operate at frequencies that may cause interference to nearby TVs and VCRs. To minimize or prevent such interference, the base of the cordless telephone should not be placed near or on top of a TV or VCR. If interference is experienced, move the cordless telephone further away from the TV or VCR. This will often reduce, or eliminate, interference.

FCC RF Exposure Warning:

The product complies with FCC radiation exposure limits set forth for an uncontrolled environment. To comply with FCC RF exposure requirements, the base unit must be installed and operated with its antenna located 20 cm (8 inches) or more between antenna and all person's body (excluding extremities of hands, wrist and feet). The handset may be carried and operated with only the optional specific belt-clip. Other non-tested belt-clips or similar body-worn accessories may not comply and must be avoided. The product must not be collocated or operated in conjunction with any other antenna or transmitter.

Notice

- This product is designed for use in the United States of America. Sale or use of this product in other countries may violate local laws.
- Cet appareil est conçu pour être utilisé aux États-Unis d'Amérique. La vente ou l'emploi de cet appareil dans certains autres pays peut constituer une infraction à la législation locale.
- Este producto está diseñado para usarse en los Estados Unidos de América.
La venta o el empleo de este producto en ciertos países puede constituir violación de la legislación local.
- この製品は、日本国外での使用を目的として設計されており、日本国内での使用は法律違反となります。従って、当社では日本国内においては原則として修理などのサービスは致しかねます。

Specifications

General

Operating environment	5 °C – 40 °C (41 °F – 104 °F)
Frequency	2.4 GHz – 2.48 GHz

Base unit

Dimensions	Approx. height 139 mm x width 136 mm x depth 127 mm (5 ¹⁵ / ₃₂ inches x 5 ¹¹ / ₃₂ inches x 5 inches)
Mass (Weight)	Approx. 300 g (0.66 lb.)
Power consumption	Standby: Approx. 2.7 W/1.8 W (PQLV19/PQLV255) Maximum: Approx. 5.0 W/3.5 W (PQLV19/PQLV255)
Power output	100 mW (max.)
Power supply	AC adaptor (120 V AC, 60 Hz)

Handset

Dimensions	Approx. height 167 mm x width 48 mm x depth 31 mm (6 ⁹ / ₁₆ inches x 1 ⁷ / ₈ inches x 1 ⁷ / ₃₂ inches)
Mass (Weight)	Approx. 140 g (0.31 lb.)
Power output	100 mW (max.)
Power supply	Ni-MH battery (2.4 V, 830 mAh)

Charger^{*1}

Dimensions	Approx. height 61 mm x width 85 mm x depth 95 mm (2 ¹³ / ₃₂ inches x 3 ¹¹ / ₃₂ inches x 3 ³ / ₄ inches)
Mass (Weight)	Approx. 90 g (0.2 lb.)
Power consumption	Standby: Approx. 1.0 W/0.5 W (PQLV19/PQLV255) Maximum: Approx. 3.0 W/2.0 W (PQLV19/PQLV255)
Power supply	AC adaptor (120 V AC, 60 Hz)

*1 KX-TG2622

Note:

- Design and specifications are subject to change without notice.
- The illustrations in these instructions may vary slightly from the actual product.

Warranty

**PANASONIC CONSUMER
ELECTRONICS COMPANY, DIVISION
OF PANASONIC CORPORATION OF
NORTH AMERICA**
One Panasonic Way,
Secaucus, New Jersey 07094

PANASONIC PUERTO RICO, INC.
San Gabriel Industrial Park,
Ave. 65 de Infantería, Km. 9.5,
Carolina, Puerto Rico 00985

Panasonic Telephone Limited Warranty

Limited Warranty Coverage

If your telephone (identified in your Operating Instructions) does not work properly because of a defect in materials or workmanship, Panasonic Consumer Electronics Company or Panasonic Puerto Rico, Inc. (collectively referred to as “the warrantor”) will, for the length of the period indicated on the chart below, which starts with the date of original purchase (“Limited Warranty period”), at its option either (a) repair your product with new or refurbished parts, or (b) replace it with a new or a refurbished product. The decision to repair or replace will be made by the warrantor.

Parts

One (1) Year

Labor

One (1) Year

During the “Labor” Limited Warranty period there will be no charge for labor. During the “Parts” Limited Warranty period, there will be no charge for parts. You must mail-in your product prepaid during the Limited Warranty period. This Limited Warranty excludes both parts and labor for batteries, antennas, and cosmetic parts (cabinet). This Limited Warranty only applies to products purchased and serviced in the United States or Puerto Rico. This Limited Warranty is extended only to the original purchaser and only covers products purchased as new. A purchase receipt or other proof of the original purchase date is required for warranty service.

To obtain service in the USA please contact:

Panasonic Services Company, Panasonic Plus Department
20421 84th Avenue South
Kent, WA 98032
Tel: 1-800-833-9626 Fax: 1-800-237-9080

For assistance in Puerto Rico call Panasonic Puerto Rico, Inc. (787)-750-4300 or fax (787)-768-2910.

For Limited Warranty service for headsets if a headset is included with this product please call Panasonic Plus Department at 1-800-833-9626.

Useful Information

When shipping the unit carefully pack, include all accessories, and send it prepaid, adequately insured and preferably in the original carton. Include a letter detailing the complaint, a return address and a day time phone number where you can be reached.

Limited Warranty Limits And Exclusions

This Limited Warranty ONLY COVERS failures due to defects in materials or workmanship, and DOES NOT COVER normal wear and tear or cosmetic damage. The Limited Warranty ALSO DOES NOT COVER damages which occurred in shipment, or failures which are caused by products not supplied by the warrantor, or failures which result from accidents, misuse, abuse, neglect, bug infestation, mishandling, misapplication, alteration, faulty installation, set-up adjustments, misadjustment of consumer controls, improper maintenance, power line surge, lightning damage, modification, introduction of sand, humidity or liquids, commercial use such as hotel, office, restaurant, or other business or rental use of the product, or service by anyone other than a Factory Servicenter or other Authorized Servicer, or damage that is attributable to acts of God.

THERE ARE NO EXPRESS WARRANTIES EXCEPT AS LISTED UNDER "LIMITED WARRANTY COVERAGE". THE WARRANTOR IS NOT LIABLE FOR INCIDENTAL OR CONSEQUENTIAL DAMAGES RESULTING FROM THE USE OF THIS PRODUCT, OR ARISING OUT OF ANY BREACH OF THIS LIMITED WARRANTY. (As examples, this excludes damages for lost time, lost calls or messages, cost of having someone remove or re-install an installed unit if applicable, travel to and from the servicer. The items listed are not exclusive, but are for illustration only.) **ALL EXPRESS AND IMPLIED WARRANTIES, INCLUDING THE WARRANTY OF MERCHANTABILITY, ARE LIMITED TO THE PERIOD OF THE LIMITED WARRANTY.**

Some states do not allow the exclusion or limitation of incidental or consequential damages, or limitations on how long an implied warranty lasts, so the exclusions may not apply to you.

This Limited Warranty gives you specific legal rights and you may also have other rights which vary from state to state. If a problem with this product develops during or after the Limited Warranty period, you may contact your dealer or Servicenter. If the problem is not handled to your satisfaction, then write to the warrantor's Consumer Affairs Department at the addresses listed for the warrantor.

PARTS AND SERVICE, WHICH ARE NOT COVERED BY THIS LIMITED WARRANTY, ARE YOUR RESPONSIBILITY.

Customer services

Customer Services Directory

Obtain Product Information and Operating Assistance; locate your nearest Dealer or Servicenter; purchase Parts and Accessories; or make Customer Service and Literature requests by visiting our Web Site at:

<http://www.panasonic.com/consumersupport>

or, contact us via the web at:

<http://www.panasonic.com/contactinfo>

You may also contact us directly at: 1-800-211-PANA (1-800-211-7262),
Monday-Friday 9 am-9 pm; Saturday-Sunday 10 am-7 pm, EST.

TTY users (hearing or speech impaired users) can call 1-877-833-8855.

Accessory Purchases

Purchase Parts, Accessories and Instruction Books online for all Panasonic Products by visiting our Web Site at:

<http://www.pasc.panasonic.com>

or, send your request by E-mail to:

npcparts@us.panasonic.com

You may also contact us directly at:

1-800-332-5368 (Phone) 1-800-237-9080 (Fax Only)

(Monday - Friday 9 am to 8 pm, EST.)

Panasonic Services Company

20421 84th Avenue South, Kent, WA 98032

(We Accept Visa, MasterCard, Discover Card, American Express, and Personal Checks)

TTY users (hearing or speech impaired users) can call 1-866-605-1277.

Service in Puerto Rico

Panasonic Puerto Rico, Inc.

San Gabriel Industrial Park, Ave. 65 de Infantería, Km. 9.5,

Carolina, Puerto Rico 00985

Phone (787)750-4300, Fax (787)768-2910

Index

- A** Answering calls: 18
 - Auto talk: 18
- B** Battery
 - Charge 11
 - Installation 11
 - Level: 12
 - Performance: 12
 - Replacement 11
- C** Call share: 19
 - Call Waiting: 19
 - Call Waiting Caller ID: 22
 - Caller ID number auto edit: 23
 - Caller ID service: 22
 - Caller list
 - Calling back 22
 - Editing 23
 - Erasing: 23
 - Storing: 23
 - Viewing 22
 - Chain dial: 21
 - Conference calls: 31
 - Connections: 10, 11
 - Customer support: 27
- D** Dialing mode: 16
 - Display
 - Contrast: 26
 - Language: 16
- E** Error messages: 35
- F** Flash: 19
 - Flash time: 27
- H** Handset locator: 30
 - Headset, optional: 34
 - Hold: 18
- I** Intercom: 30
 - Interrupt tone: 26
- K** Key tone: 26
- L** Line mode: 27
- M** Making calls: 17
 - Message alert: 29
 - Missed calls: 22
 - Mute: 19
- P** Pause: 17
 - Phonebook: 20
 - Phonebook: copy 21
 - Pulse service: 19
- R** Redial list: 17
 - Registration: 32
 - Ringer off: 18, 26
 - Ringer tone: 26
 - Rotary service: 19
- S** SP-phone: 17
- T** Tone: 19
 - Transferring calls: 31
 - Troubleshooting: 36
 - TTY: 9, 45
- V** VE (voice enhancer): 19
 - VM (Voice Mail): 28
 - Voice Mail access number: 28
 - Volume
 - Handset ringer: 26
 - Receiver: 17
 - Speaker: 17
- W** Wall mounting
 - Base unit: 33
 - Charger: 33
 - Warranty: 43

If you need assistance with setup or operation

- 1** Visit our website: <http://www.panasonic.com/phonehelp>
- 2** Contact us via the web at: <http://www.panasonic.com/contactinfo>
- 3** Call us at: 1-800-211-PANA (1-800-211-7262) or 1-800-833-9626
TTY users (hearing or speech impaired users) can call 1-877-833-8855.

When you ship the product

- Carefully pack your unit, preferably in the original carton.
- Attach a letter, detailing the symptom, to the outside of the carton.
- Send the unit to Panasonic Services Company Customer Servicer, prepaid and adequately insured.
- Do not send your unit to Panasonic Consumer Electronics Company listed on the back cover or to executive or regional sales offices. These locations do not repair consumer products.

IMPORTANT!

If your product is not working properly. . .

- 1 Read this **Operating Instructions**
 - If you lost Operating Instructions, you can download at <http://www.panasonic.com/phonehelp>
- 2 Visit our website:
<http://www.panasonic.com/phonehelp>
 - FAQs and troubleshooting hints are available.
- 3 Contact us via the web at:
<http://www.panasonic.com/contactinfo>
- 4 Call us at:
1-800-211-PANA (1-800-211-7262)
 - Monday - Friday 9:00am - 9:00pm (EST),
Saturday/Sunday 10:00am - 7:00pm (EST)

To order a replacement battery,
please call: 1-800-332-5368

Or visit: <http://www.panasonic.com/batterystore>

Panasonic Consumer Electronics Company,
Division of Panasonic Corporation of North America
One Panasonic Way, Secaucus, New Jersey 07094

Panasonic Puerto Rico, Inc.
San Gabriel Industrial Park, Ave. 65 de Infantería, Km. 9.5,
Carolina, Puerto Rico 00985

Copyright:

This material is copyrighted by Panasonic Communications Co., Ltd., and may be reproduced for internal use only. All other reproduction, in whole or in part, is prohibited without the written consent of Panasonic Communications Co., Ltd.

© 2005 Panasonic Communications Co., Ltd. All Rights Reserved.